

Audiovox CCS100 On a Stratoliner or Roadliner

MATERIALS LIST:

- 1 - Audiovox CCS100 Cruise Control System (eBay, under \$100.00)
- 1- 1-1/4" piece of PVC pipe (approx 6"-8")
- 2 - 1-1/4" PVC Caps
- 1 - PVC Glue
- 2 - 1/8" NPT Vacuum Fittings
- 1 - Teflon Tape or pipe compound (your choice)
- 2 - 10 ohm 1/2 watt resistors (Radio Shack #271-132)
- 1 - Diode [epoxy rectifier] (Radio Shack #276-1144)
- 1 - Vacuum check valve (AZ, Pep Boys, Wal-Mart, etc.)
- 5 - feet of 1/8" or 1/4" heat shrink tubing
- 12" black zip cable ties as needed

This is a combination of ideas from three different Liner installations. One by Arkyliner (Darryl), another by 06sevrod, and one by K5TGJ (JackK, that's me).

1. Remove the seat, tool kit, chrome covers on each side (covering coils and fuel lines). Remove the gauge cluster (there are 4 plugs you need to unplug prior to removing the gauge cluster and tank) and remove tank (for instructions on removing the tank, click here:

<http://www.linerwiki.com/index.php?title=TankRemoval>.

*I also found it useful to remove the security cover for the seat along with the seat bracket...made it easier to get to the fuel hoses.

2. Here's a picture of the kit contents:



3. You can remove the gray and black wire pair from the 10-pin connector since it will not be needed.

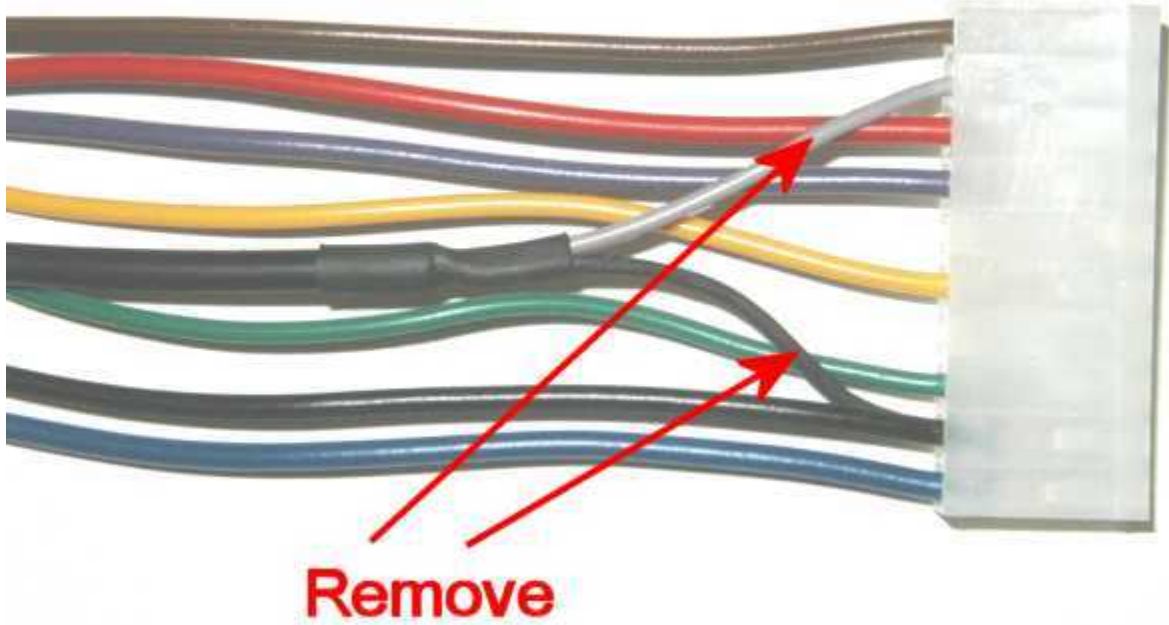

4. If you have the PR BAK (or other BAK), locate the servo as shown in the picture below. Drill and tap two holes for screws to mount the servo.

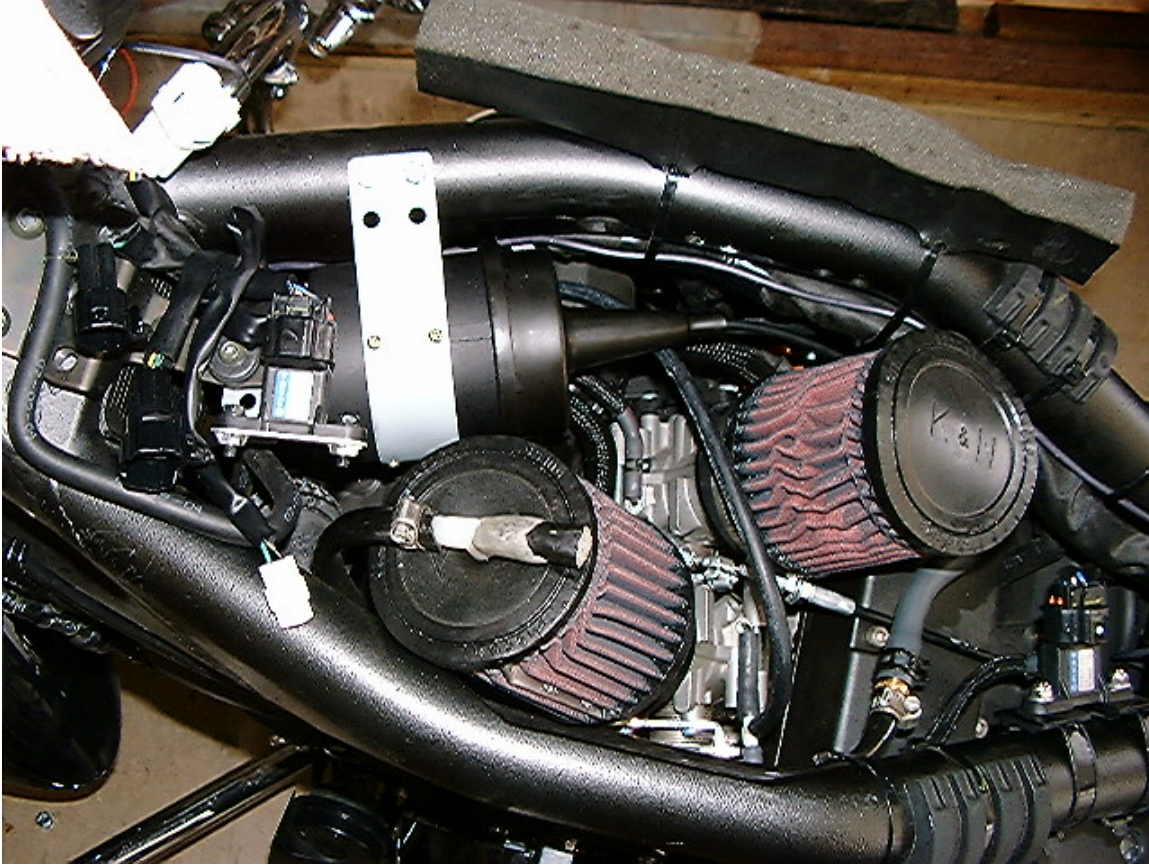

If you do not have a BAK but still have the airbox, use Darryl's method:

The only place I could find was inside the air box toward the front of the box clearing the TB intakes and the air filter. I do not have a picture of this location at this time but I probably will have soon. It will just barely fit and must be moved far enough to the rear of the box for the indentions in the top of the air box to clear. Once you get the top of the box off you will see what I am talking about. I would think that those with aftermarket air filters may have more room to work with than the standard air box allows.

On this installation you must be willing to drill 3 holes in the air box. One for the servo control cable at the very rear of the box, one for the wiring harness on the left side of the box, and one in the bottom of the box over to the right side for the vacuum. Of course all of these MUST be sealed very well to preserve the integrity of the air box.

My installation leaves the vacuum port looking straight up and is somewhat cramped by the air box top. I would suggest you try to rotate the servo so you have more room for the vacuum line. The mounting holes I drilled were in the bottom of the box, however I would think it could be rotated so that the attachment holes could be on the left side and give the desired rotation. The metal mounting plate may need to be reformed to accommodate this procedure. I used the cut off portion of the mounting plate as a stiffener on the bottom exterior of the air box.

5. Before you mount the servo and its bracket, open the back of the servo and you will see several DIP switches, an LED, and a black jumper. Since the motorcycle is a manual shift, remove the jumper now.

The DIP settings used are 2,000 ppm (4,000 does not always allow the cruise to be set any lower than 3,000 RPM) and medium. That means that only switch #7 is ON and all others are OFF. This has been found to work very well on the Liners.

Ensure that the key is off and nothing is on when you change a DIP switch setting. Everything else regarding the DIP switches can be obtained from the instructions in the kit.

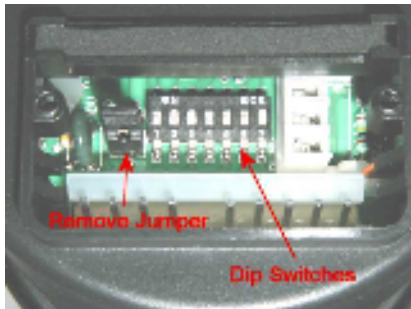

6. Connect the supplied vacuum line to the fitting on the servo.
7. Connect the 10-pin connector to the mating connector in the servo and replace the cover.
8. Mount the servo by installing two screws to hold the bracket to the frame. Route the servo cable and vacuum hose to the back of the bike. Lay the wire bundle out of the way. The routing for these will be finalized in a later step.
9. Separate the black wire, cut it to length or coil it up. Solder a terminal lug on the end and mount the lug under one of the screws that mounts the servo bracket.

10. Route the servo throttle cable along the frame on the right side. Circle it back toward the front and route it between the two throttle bodies to the right front of the open area. Next, circle the cable back around to the left so it runs parallel to the throttle cables. Be sure to make the bends in the cable wide and gentle so you don't kink the cable.
11. Use the supplied clamp (#18) and screws (#32) to clamp the servo cable to the upper throttle cable. You can wait to tie wrap the cable to various point on the frame until you have finished running all the wires and vacuum hose or go ahead and use some cable ties and secure it now. I just tied it in several places to keep it from bulging out, getting in the way of anything, or just looking unsightly.

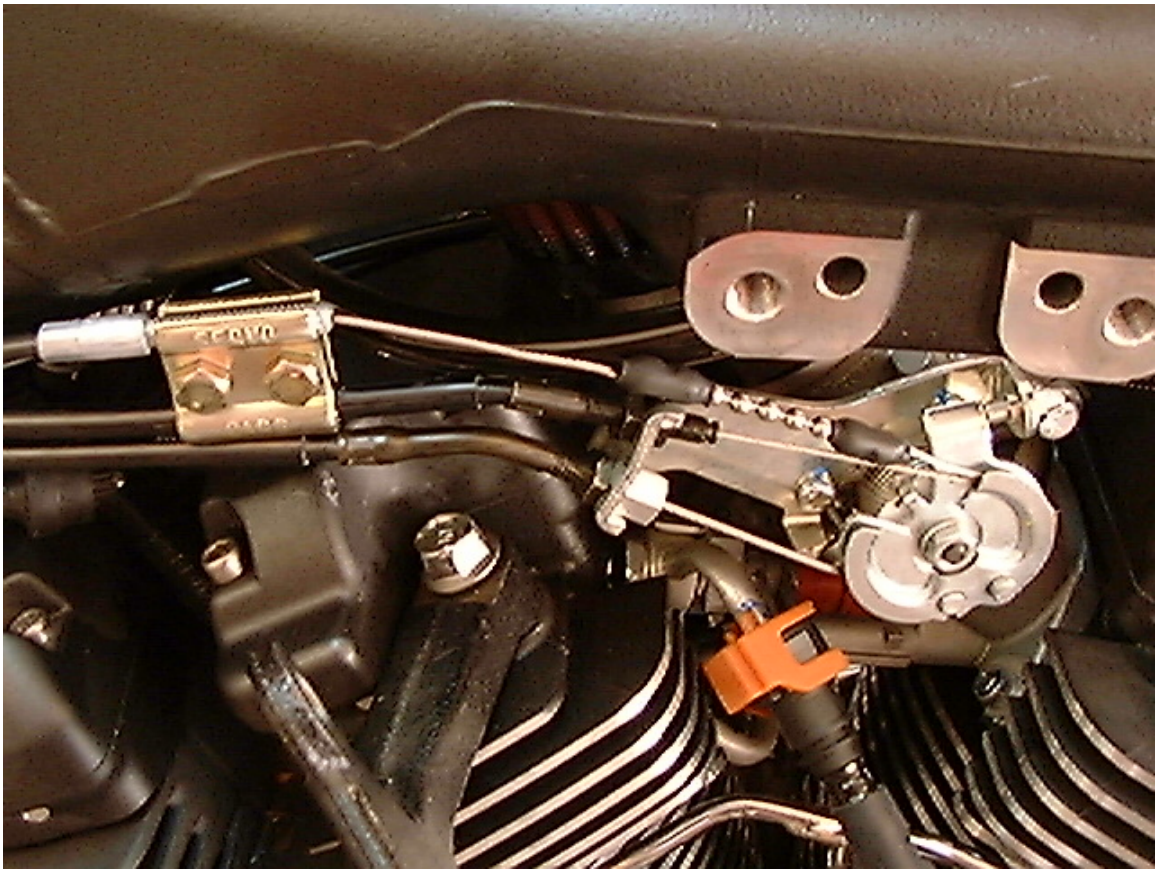

12. You are going to use the shorter of the two cable loops (see pic) and attach them to the throttle cable. Remove the motor mount brace on the left side to give you access to the bellcrank on the throttle body.



13. To remove the throttle cable, use the adjuster at the throttle grip on the handlebar. Adjust it as loose as it will go. Then you can have a helper hold the throttle grip in the fully closed position or use something to secure it so it won't twist. At the bellcrank end of the throttle cable loosen the front nut all the way, do not mess with the rear nut. This will gain you slack and you can remove the throttle cable from its mounting bracket.
14. Push the stop on the bellcrank to open the throttle all the way. This will add more slack on the cable and enable you to remove it from the assembly. Simply work the throttle cable out of the groove and up to the slot and then press the cable and the pin out of the bellcrank.
15. Place the loop portion of the short cable (#29) over the pin on the end of the throttle cable and reinsert the throttle cable back into the bellcrank. See the picture below. Last, reattach the throttle cable to its bracket. Tighten only the front nut, being careful not to mess with the rear nut, and you are back to an OEM setup.
16. Lay the servo cable in the track on the bellcrank.

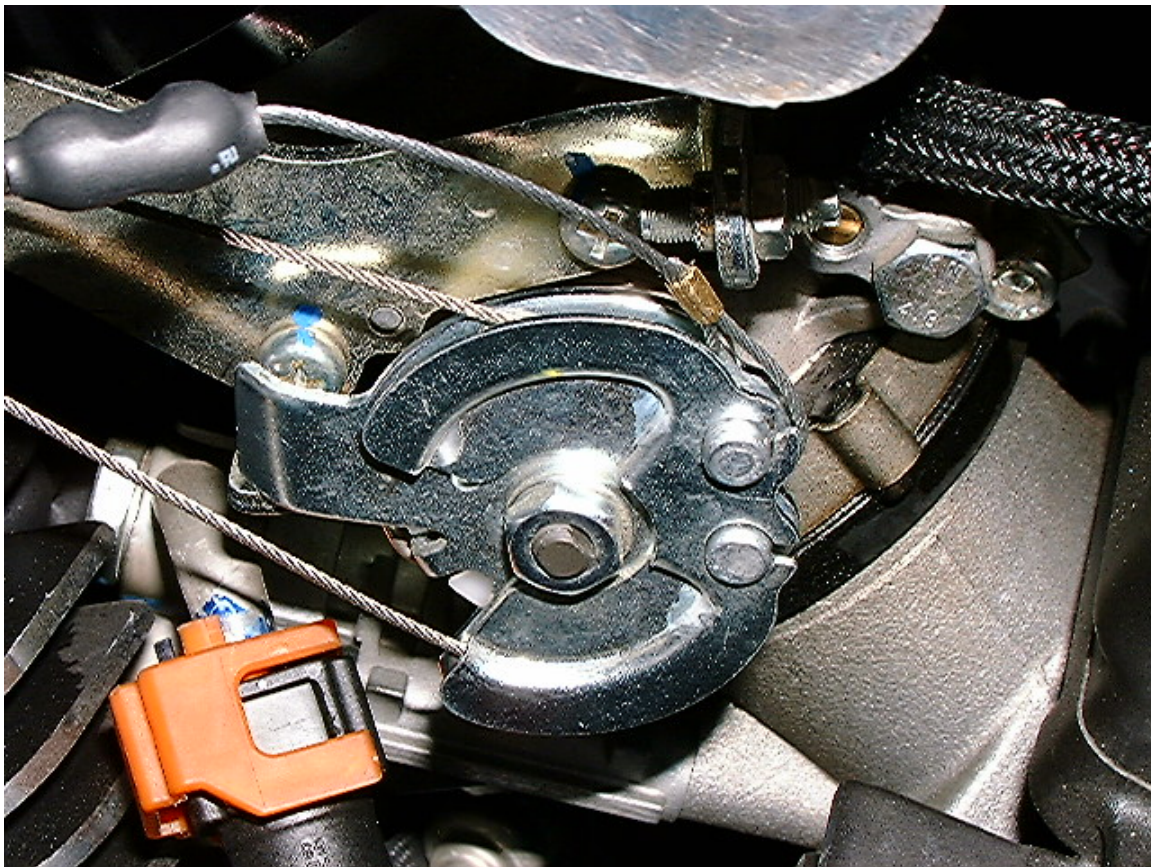

17. Get the bead chain (#20) and cut it to a length of seven (7) beads. Insert one of the end beads into one of the bead chain couplers (#24). My couplers were closed so tight I had to spread them open with two pairs of needle-nose pliers. After inserting the ball, I squeezed them back together. Insert the ball of the short cable (#29) into the other end of the bead coupler.
18. Put one of the sleeves (#23) over the coupler. I couldn't find these in my kit so I used shrink sleeving as shown in the picture.
19. After you have this done, use another ball chain link to attach the chain to the throttle cable. Be sure to put a sleeve onto the cable before you make the final connection between the throttle cable and the ball chain. You only want a maximum of 1/8" play with the servo cable fully extended. I adjusted mine to have almost zero play. The servo cable is now complete.
20. You now need to readjust the throttle cable at the grip to take up all the slack. Refer to the owner's manual or service manual for help if needed.

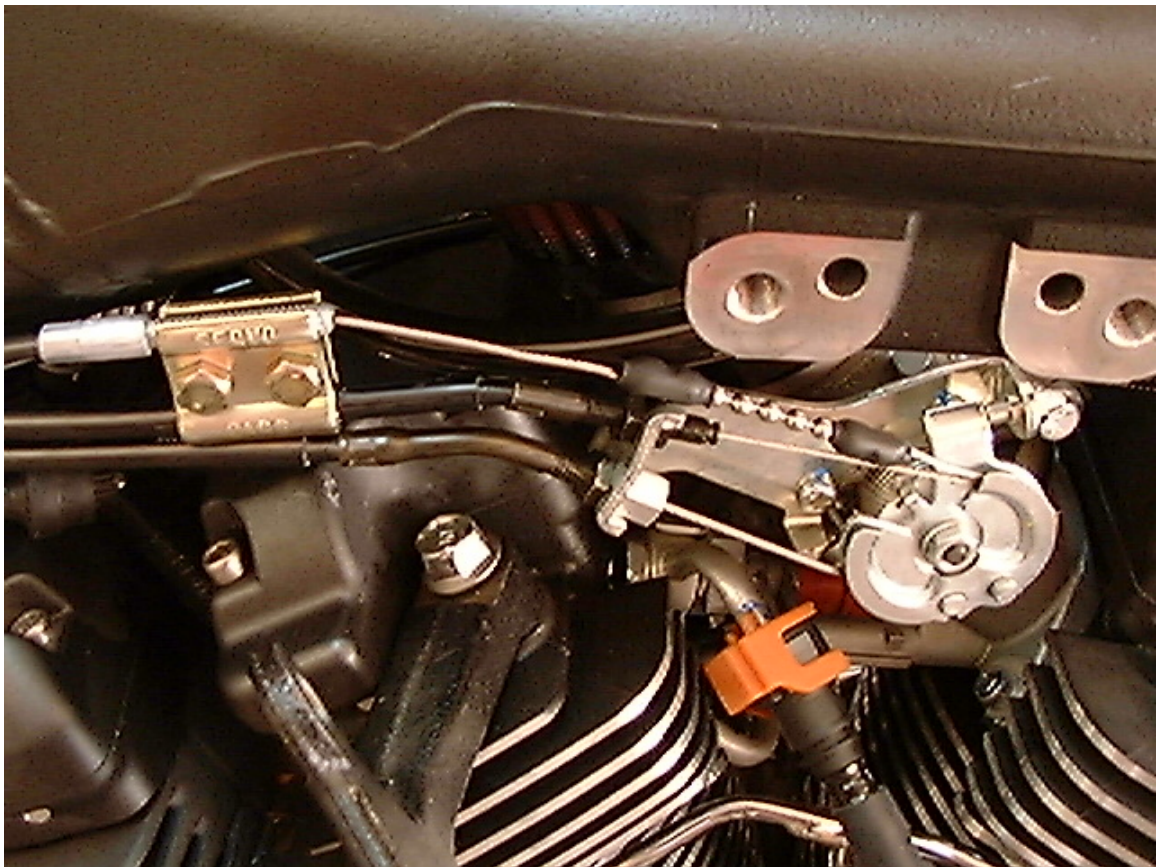

21. Build your vacuum canister using PVC pipe and end caps. I found this works really well in the tool kit place and you can use the strap for the tool kit to hold down the vacuum tube. After you assemble your vacuum tube, drill and tap it for two 1/8" NPT barb fittings. Use either Teflon tape or pipe compound to seal the fittings. Use PVC glue for the pipe. Here's a picture of a completed vacuum canister installed.



Here's what Darryl did (rather ingenious I think):

I drilled and tapped the engine crash guard to use as the vacuum tank. My guard is a MC Enterprises guard and worked out rather well. The steel gets rather hard after the chroming process so if you choose this method please be cautious when drilling and tapping. I use a product called Rapid Tap when doing that kind of work. It helps to keep your tool cool as well as lubricated.

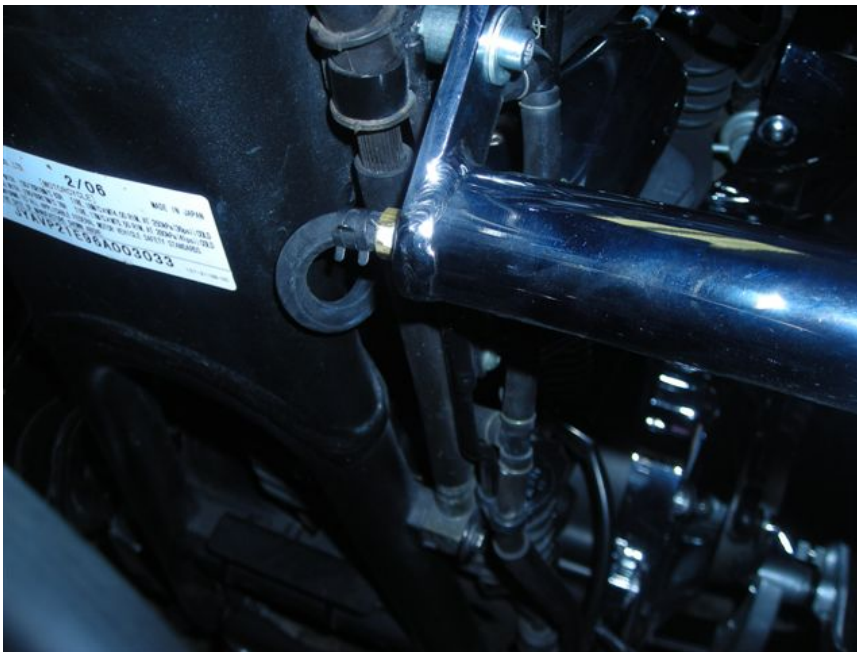
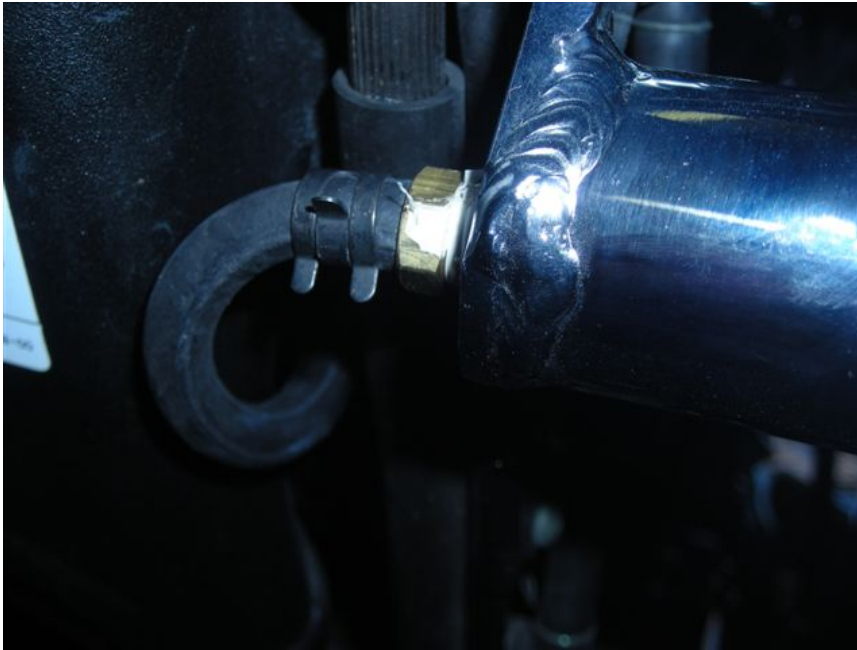

22. Using some of the vacuum hose in the kit and the larger vacuum adapter supplied in the kit, tap into your vacuum line coming from the left side manifold. You must cut and remove the sheathing but keep it for later. Insert the tee into the vacuum line and, using a short piece of vacuum line, insert the check valve with the vacuum pulling toward the motor (the side that you can suck air through points toward the engine). Run the other side of the check valve to one fitting on your vacuum canister.



23. Route the vacuum line connected to the servo, running along the frame of the bike, to the other fitting on the canister. If either of the lines is not long enough you may have to buy a 2-1/2 foot piece at an auto store. Vacuum connections are now complete.

24. I used Darryl's suggestion to make a bracket to mount the control switch (#3): Pick up a piece of 1/8" aluminum from Lowe's that is about 2" wide and at least 5" long. Bend a 90 degree bend 2" from the end and then cut it off at 3" leaving a 2" x 3" angle piece. Next cut a piece 2" x 2" and weld it to the angle piece on the back side only. I installed the 2" x 2" piece in the approximate center of the 2" x 3" bracket.

You have to cut a slot in the 2" x 2" piece to pass the wires from the control switch. Using the template that comes with the kit, mark the piece. Drill a 1/4" hole at the top and bottom of the marked area and saw out the remaining metal between the two holes. Use a file to smooth the edges. This creates a slot for the control pad wires.

You'll need to drill a hole in the bracket so it can be mounted under the mirror stem of the left mirror. You'll also need to relieve the area where the bracket would hit the handlebar. Refer to Darryl's pictures for details.

After rounding the corners to match, sand and polish the bracket so it will look good. I attached double sided tape to the back of the bracket for added support before attaching with the mirror bolt. Before attaching the control pad to the bracket seal the back of the pad with silicone. IMHO it looks like a factory install.

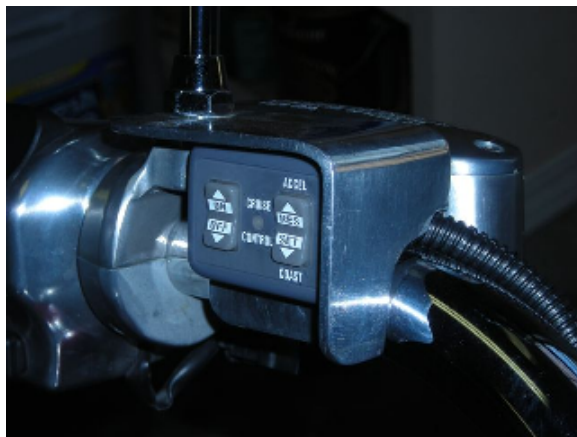
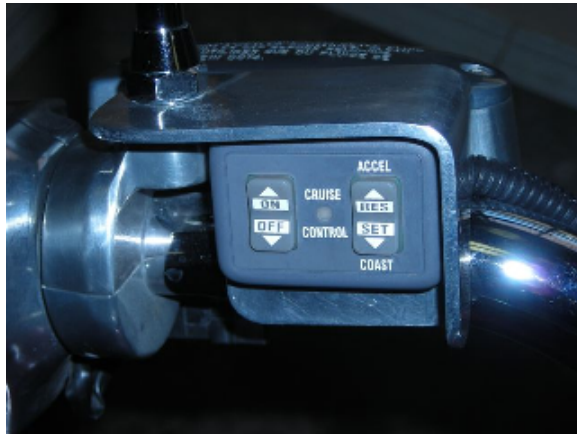



25. After you are satisfied with your bracket, you might need to lengthen your wires from the control unit. Temporarily mount the control switch to the bracket but don't peel the backing off the mounting tape. Use a rubber band to hold the control in place.

After you have lengthened the wires, if needed, and decided where you want them to mate up with the wires from the servo, you can use the convoluted tubing (#6) to encase and protect the wires. This will give it a factory look.

Feed the wires from the control switch through the hole in the bracket and route the wires along the handlebar and down along the clutch cable. Trial fit the wires to where you want them to go. Route the wires between the headlamp assembly and frame. I ran mine down to just behind the left frame piece that connects the triple tree.

Here I separated the black wire, cut it to length, soldered a lug on the end, and mounted the lug under an existing screw that holds the wire guides. I had cut the convoluted tubing too short so I used some heat shrink sleeving over the wires.

You have two options for the gray wire. You can simply connect it to the red wire or run it inside the frame to a 12 volt source. The simplest is to connect it to the red wire, since the red wire will have 12 volts on it.



The wires were not long enough to reach inside the frame so I cut them to length and attached the 4-pin white connector right there. If I had thought ahead I think I would have lengthened them to reach inside the frame.

26. To connect the wires from the servo I placed them in convoluted tubing, routing them around to the left and to the front where they would meet the white connector from the control switch. Leave the blue and purple wires out of the tubing. They need to be connected elsewhere.

I didn't like all the extra length of wire so I cut the red, yellow, green, and brown wires about 3" from the ends. That leaves the connector pins on these 3" long wires. Insert these four wires into the other white connector, making sure to match the colors. Measure and cut the wires coming from the servo to a length that will allow you to plug the two connectors together and splice the two sets of four wires together. (The convoluted tubing can be opened and the wires pulled out to allow adequate length for the splices.

To splice the wires, strip about 1/2" of insulation off the end of each wire. Slide a piece of shrink sleeving over each wire of one of the sets of four wires. Twist the matching colors of wires together and solder them. Slide the sleeving down over the solder joint and use the soldering iron or heat gun (some hair dryers are hot enough) to shrink the sleeving. Tuck the wires back inside the convoluted tubing and connect the two white connectors together. Use some cable ties to secure the connectors and the convoluted tubing.

27. Back at the servo, pull the red wire out of the tubing and strip about 1/2" of insulation off it. Don't worry if you cut it, it will be soldered. Strip about 1/2" of insulation off the red wire you cut off at the connector end and wrap it around the red wire from the servo. Use electrical tape to wrap around the joint and tuck the joint back inside the convoluted tubing.

Remove the right side coil cover. Feed the blue wire down to the coils. Route it away from the spark plug wires to about 1" beyond the front most coil wire. This wire has a noise suppressor in it. I suggest you keep that since to be sure the noise from the coil doesn't get into the instrument cluster.

You will use the female T-tap connector (#14) to attach the spade terminal on the end of the blue wire to the orange coil wire. Then you can either cut and splice the blue wire to length or tuck the extra length inside the convoluted tubing.

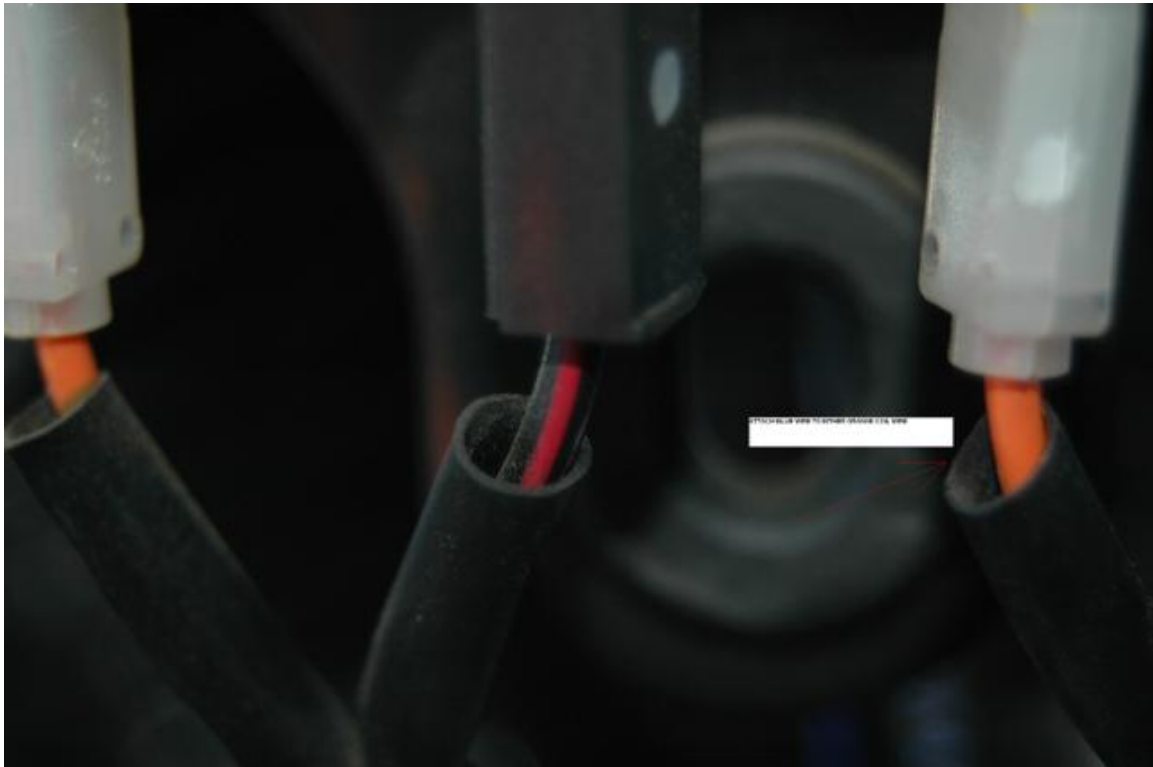

Using 3 or 4 of the small cable ties (#4), tie the blue wire to the other wires of the coils.

28. The red wire from the servo goes to a 12 volt source and one can be found inside the pouch under the ECU. The orange wire also must connect to a 12 volt source. I just spliced the red and orange wires together. The instructions say to connect the red wire to a constant 12 volts. That doesn't seem to be necessary. It works fine connected to a switched 12 volt source.

There's a 2-pin connector with a dummy plug inside the pouch under the ECU. Attach the red and orange wires to the brown wire in this connector with a scotch lock connector (#13) that pierces the wire (no cutting).

29. The purple wire is where you will use the resistors and diode, due to the fact that the Liners have LED lights. Under the computer there is a clear 6-pin plug that has a yellow wire coming from it. That yellow wire is the wire that is hot when the brakes are activated (brake light). Follow the diagram below for hooking up the resistors and diode. The wire is the yellow wire.



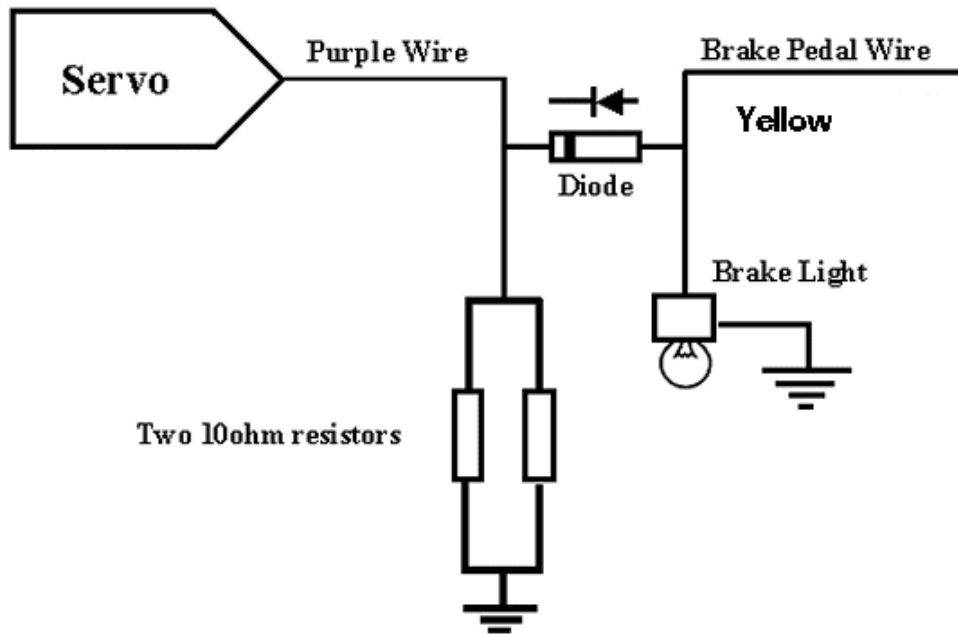

Mount the resistors and diode in a small pill bottle and run the wires out 2 holes in the lid.

Below is a wiring diagram of the entire system.

